

P-CHANNEL MOS FIELD EFFECT TRANSISTOR  
FOR HIGH SPEED SWITCHING

DESCRIPTION

The 2SJ462 is a switching device which can be driven directly by an IC operating at 3 V.

The 2SJ462 features a low on-state resistance and can be driven by a low voltage power source, so it is suitable for applications such as power management.

FEATURES

- Can be driven by a 2.5 V power source.
  - New-type compact package.
- Has advantages of packages for small signals and for power transistors, and compensates those disadvantages.

- Low on-state resistance.

$R_{DS(ON)}$  : 0.29  $\Omega$  MAX. @ $V_{GS} = -2.5$  V,  $I_D = -0.5$  A

$R_{DS(ON)}$  : 0.19  $\Omega$  MAX. @ $V_{GS} = -4.0$  V,  $I_D = -1.0$  A

ABSOLUTE MAXIMUM RATINGS ( $T_A = +25$  °C)

Drain to Source Voltage	$V_{DSS}$	-12	V
Gate to Source Voltage	$V_{GSS}$	$\pm 8.0$	V
Drain Current (DC)	$I_{D(DC)}$	$\pm 2.5$	A
Drain Current (pulse)	$I_{D(pulse)}$	$\pm 5.0^*$	A
Total Power Dissipation	$P_T$	2.0**	W
Channel Temperature	$T_{ch}$	150	C
Storage Temperature	$T_{stg}$	-55 to +150	C

\*  $PW \leq 10$  ms, Duty Cycle  $\leq 1$  %

\*\* Mounted on ceramic board of 7.5 cm<sup>2</sup> × 0.7 mm

Package Drawings (unit : mm)

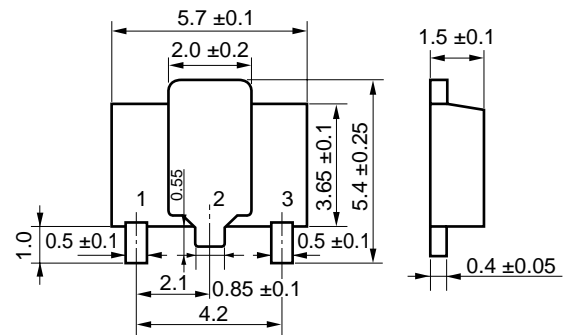

Equivalent Circuit

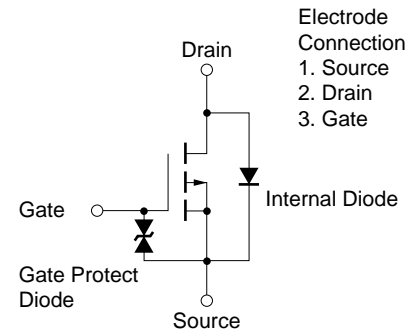

Marking : UA3

ELECTRICAL SPECIFICATIONS (T<sub>A</sub> = +25 °C)

Parameter	Symbol	MIN.	TYP.	MAX.	Unit	Conditions
Drain Cut-off Current	I <sub>DSS</sub>			-10	μA	V <sub>DS</sub> = -12 V, V <sub>GS</sub> = 0
Gate Leakage Current	I <sub>GSS</sub>			±10	μA	V <sub>GS</sub> = ±8.0 V, V <sub>DS</sub> = 0
Gate Cut-off Voltage	V <sub>GS(off)</sub>	-0.7	-1.0	-1.3	V	V <sub>DS</sub> = -3.0 V, I <sub>D</sub> = -1.0 mA
Forward Transfer Admittance	y <sub>fs</sub>	1.5			S	V <sub>DS</sub> = -3.0 V, I <sub>D</sub> = -1.0 A
Drain to Source On-State Resistance	R <sub>DS(on)1</sub>		195	290	mΩ	V <sub>GS</sub> = -2.5 V, I <sub>D</sub> = -0.5 A
Drain to Source On-State Resistance	R <sub>DS(on)2</sub>		135	190	mΩ	V <sub>GS</sub> = -4.0, I <sub>D</sub> = -1.0 A
Input Capacitance	C <sub>iss</sub>		940		pF	V <sub>DS</sub> = -3.0 V, V <sub>GS</sub> = 0
Output Capacitance	C <sub>oss</sub>		835		pF	f = 1.0 MHz
Reverse Transfer Capacitance	C <sub>rss</sub>		495		pF	
Turn-On Delay Time	t <sub>d(on)</sub>		45		ns	V <sub>DD</sub> = -3.0 V, I <sub>D</sub> = -1.0 A
Rise Time	t <sub>r</sub>		225		ns	V <sub>GS(on)</sub> = -3.0 V, R <sub>G</sub> = 10 Ω
Turn-Off Delay Time	t <sub>d(off)</sub>		140		ns	R <sub>L</sub> = 3.0 Ω
Fall Time	t <sub>f</sub>		195		ns	
Total Gate Charge	Q <sub>G</sub>		12		nC	V <sub>DS</sub> = -8 V, I <sub>D</sub> = -2.5 A
Gate to Source Charge	Q <sub>GS</sub>		2		nC	V <sub>GS</sub> = -3.0 V, I <sub>G</sub> = -2 mA
Gate to Drain Charge	Q <sub>GD</sub>		7		nC	
Diode Forward Voltage	V <sub>F(S-D)</sub>		-0.86		V	I <sub>F</sub> = -2.5 A, V <sub>GS</sub> = 0
Reverse Recovery Time	t <sub>rr</sub>		150		ns	I <sub>F</sub> = -2.5 A, V <sub>GS</sub> = 0
Reverse Recovery Charge	Q <sub>rr</sub>		160		nC	di/dt = 50 A/μs

DERATING FACTOR OF FORWARD BIAS SAFE OPERATING AREA

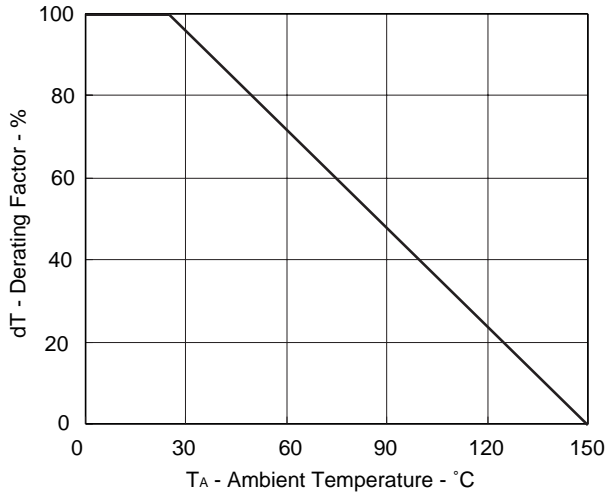

FORWARD BIAS SAFE OPERATING AREA

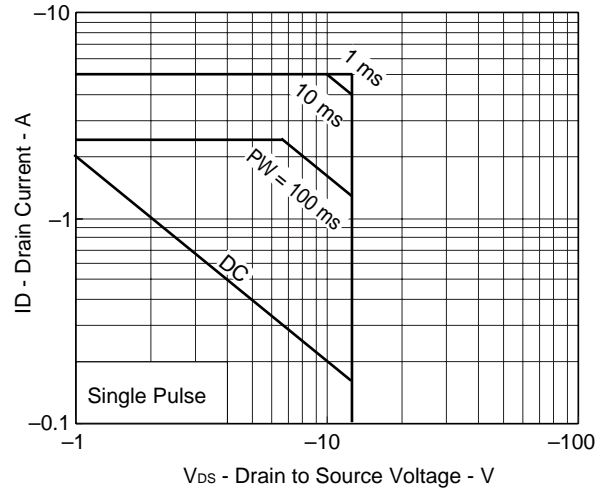

DRAIN CURRENT vs. DRAIN TO SOURCE VOLTAGE

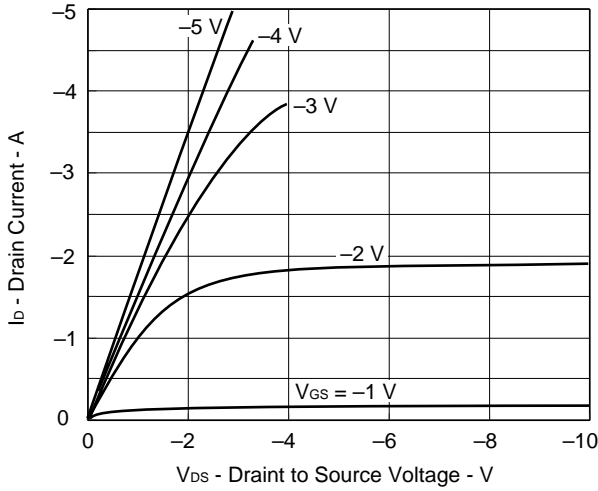

TRANSFER CHARACTERISTICS

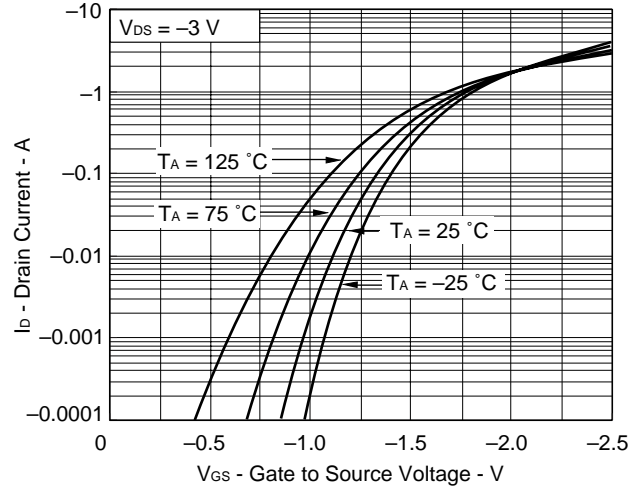

FORWARD TRANSFER ADMITTANCE vs. DRAIN CURRENT

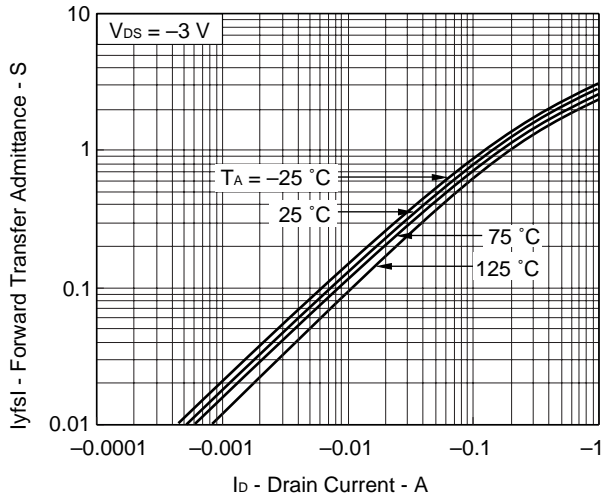

DRAIN TO SOURCE ON-STATE RESISTANCE vs. DRAIN CURRENT

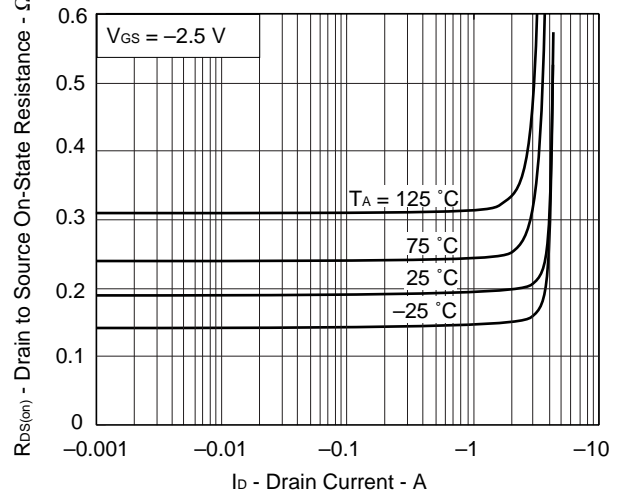

DRAIN TO SOURCE ON-STATE RESISTANCE vs. DRAIN CURRENT

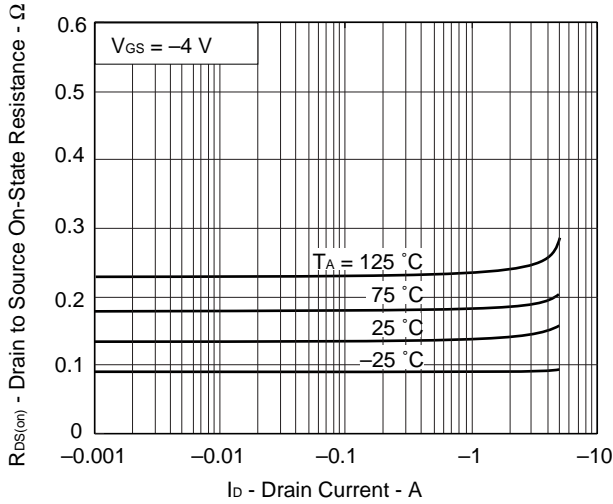

DRAIN CURRENT vs. DRAIN TO SOURCE VOLTAGE

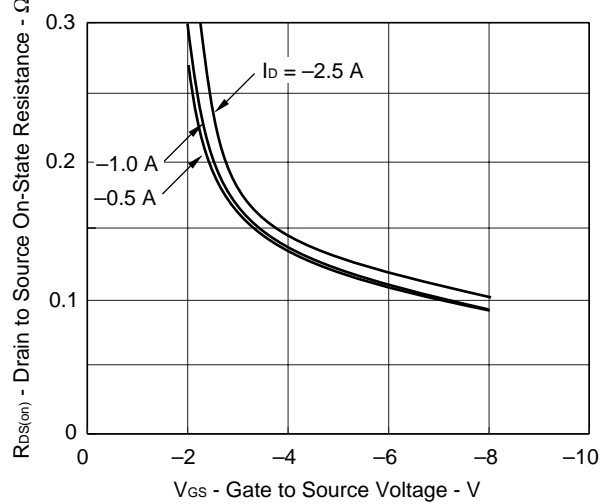

CAPACITANCE vs. DRAIN TO SOURCE VOLTAGE

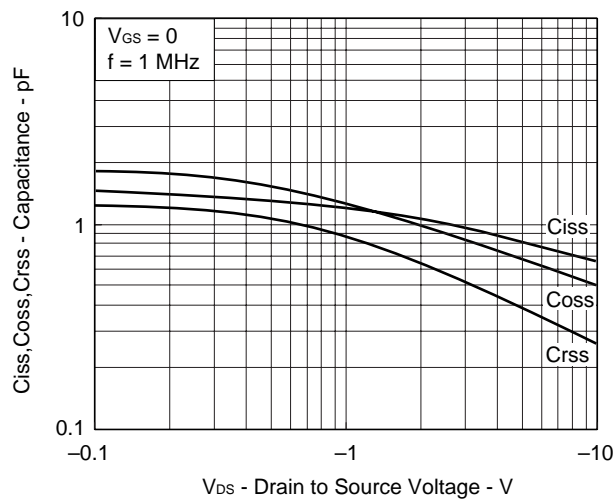

SWITCHING CHARACTERISTICS

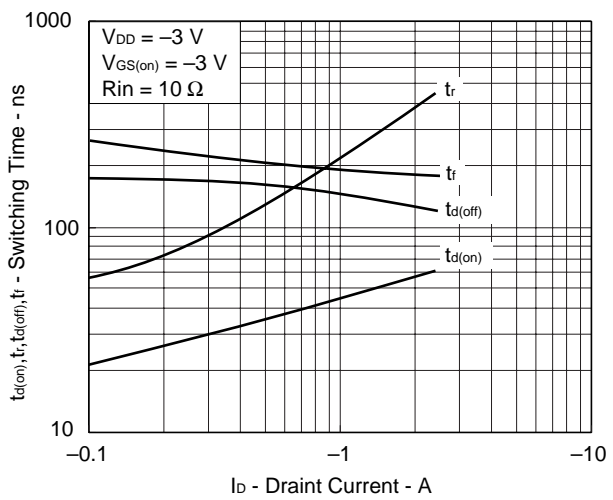

SOURCE TO DRAIN DIODE FORWARD VOLTAGE

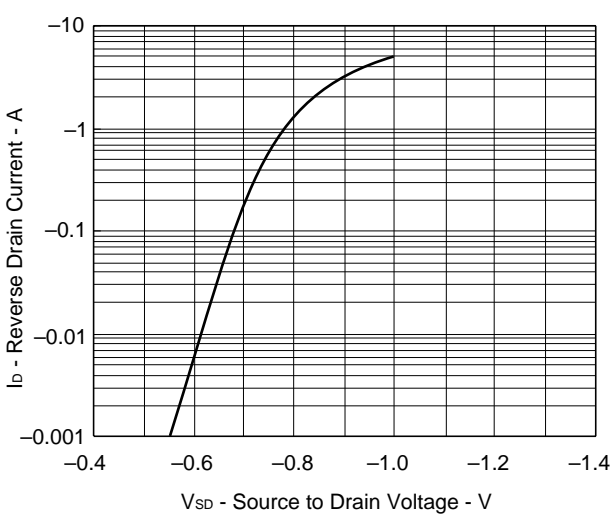

DYNAMIC INPUT/OUTPUT CHARACTERISTICS

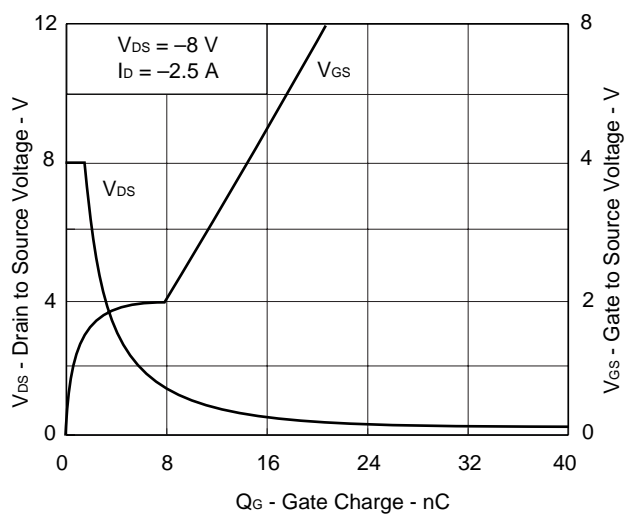

**REFERENCE**

Document Name	Document No.
NEC semiconductor device reliability/quality control system	TEI-1202
Quality grade on NEC semiconductor devices	IEI-1209
Semiconductor device mounting technology manual	C10535E
Guide to quality assurance for semiconductor devices	MEI-1202
Semiconductor selection guide	X10679E

No part of this document may be copied or reproduced in any form or by any means without the prior written consent of NEC Corporation. NEC Corporation assumes no responsibility for any errors which may appear in this document.

NEC Corporation does not assume any liability for infringement of patents, copyrights or other intellectual property rights of third parties by or arising from use of a device described herein or any other liability arising from use of such device. No license, either express, implied or otherwise, is granted under any patents, copyrights or other intellectual property rights of NEC Corporation or others.

While NEC Corporation has been making continuous effort to enhance the reliability of its semiconductor devices, the possibility of defects cannot be eliminated entirely. To minimize risks of damage or injury to persons or property arising from a defect in an NEC semiconductor device, customer must incorporate sufficient safety measures in its design, such as redundancy, fire-containment, and anti-failure features.

NEC devices are classified into the following three quality grades:

“Standard”, “Special”, and “Specific”. The Specific quality grade applies only to devices developed based on a customer designated “quality assurance program” for a specific application. The recommended applications of a device depend on its quality grade, as indicated below. Customers must check the quality grade of each device before using it in a particular application.

Standard: Computers, office equipment, communications equipment, test and measurement equipment, audio and visual equipment, home electronic appliances, machine tools, personal electronic equipment and industrial robots

Special: Transportation equipment (automobiles, trains, ships, etc.), traffic control systems, anti-disaster systems, anti-crime systems, safety equipment and medical equipment (not specifically designed for life support)

Specific: Aircrafts, aerospace equipment, submersible repeaters, nuclear reactor control systems, life support systems or medical equipment for life support, etc.

The quality grade of NEC devices in “Standard” unless otherwise specified in NEC's Data Sheets or Data Books. If customers intend to use NEC devices for applications other than those specified for Standard quality grade, they should contact NEC Sales Representative in advance.

Anti-radioactive design is not implemented in this product.